

# Service Manual

# THE FISHER<sup>®</sup>

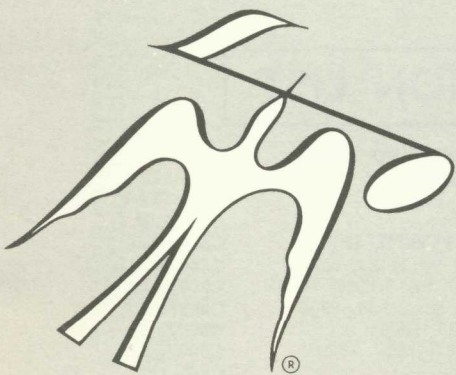
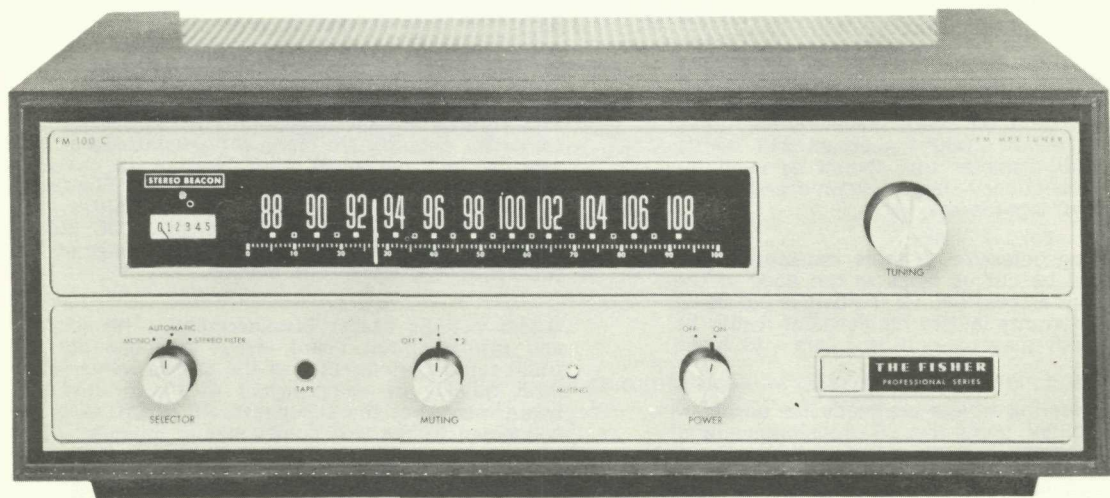

# FM-100-C

CHASSIS SERIAL NUMBERS  
BEGINNING 10000

\$1.00

FISHER RADIO CORPORATION • LONG ISLAND CITY 1 • NEW YORK

(c) www.fisherconsoles.com

**CAUTION:** This is a FISHER precision high-fidelity instrument. It should be serviced only by qualified personnel — trained in the repair of transistor equipment and printed circuitry.

## EQUIPMENT AND TOOLS NEEDED

The following are needed to completely test and align modern high-fidelity instruments such as amplifiers, tuners, and receivers.

### Test Instruments

Vacuum-Tube Voltohmmeter DC VTVM  
 Audio (AC) Vacuum-Tube Voltmeter (AC VTVM)  
 Oscilloscope (Flat to 100 kc minimum)  
 Audio (Sine-wave) Generator  
 Intermodulation Analyzer  
 Sweep (FM) Generator (88 to 108 mc)  
 Marker Generator  
 Multiplex Generator (preferably with RF output — FISHER Model 300 or equal).

### Miscellaneous

Adjustable-Line-Voltage Transformer or line-voltage regulator  
 Load Resistors (2) — 8-ohm, 50-watt (or higher)  
 Stereo source (Turntable with stereo cartridge or Tape Deck)  
 Speakers (2) Full-range, for listening tests  
 Soldering iron (with small-diameter tip). Fully insulated from power line.

## PRECAUTIONS

Many of the items below are included just as a reminder — they are normal procedures for experienced technicians. Shortcuts can be taken but often they cause additional damage — to transistors, circuit components or the printed-circuit board.

**Soldering**—A well-tinned, hot, clean soldering iron tip will make it easier to solder without damage to the printed-circuit board or the many many circuit components mounted on it. It is not the wattage of the iron that counts — it is the heat available at the tip. Low-wattage soldering irons will often take too long to heat a connection — pigtail leads will get too hot and damage the part. Too much heat, applied too long, will damage the printed-circuit board. Some 50-watt irons reach temperatures of 1,000° F — others will hardly melt solder. Small-diameter tips should be used for single solder connections — larger pyramid and chisel tips are needed for larger areas.

- When removing defective resistors, capacitors, etc., the leads should be cut as close to the body of the circuit component as possible. (If the part is not being returned for in-warranty factory replacement it may be cut in half — with diagonal-cutting pliers — to make removal easier.)
- Special de-soldering tipleths are made for unsoldering multiple-terminal units like IF transformers and electrolytic capacitors. By unsoldering all terminals at the same time the part can be removed with little chance of breaking the printed-circuit board.
- Always disconnect the chassis from the power line when soldering. Turning the power switch OFF is not enough. Power-line leakage paths, through the heating element, can destroy transistors.

- Use care when making connections to speakers and output terminals. Any frayed wire ends can cause shorts that may burn out the output transistors — they are direct-coupled to the speakers. There is no output transformer — nothing to limit current through the transistors except the fuses. To reduce the possibility of shorts at the speakers, lugs should be used on the exposed ends — at least the ends of the stranded wires should be tinned to prevent frayed wire ends. The current in the speakers and output circuitry is quite high. Any poor contact or small-size wire, can cause power losses in the speaker system. Use 14 or 16 AWG for long runs of speaker-connecting wiring.

**DC-Voltage Measurements**—These basic tests of the transistor circuitry are made without the signal generator. Without any signal input measure the circuit voltages — as indicated on the schematic. The voltage difference between the base and the emitter should be in the millivolt range — a sensitive DC meter is needed for these readings. A low-voltage range of 1 volt, full scale — or lower — is needed.

**Audio-Voltage (gain) Measurements**—The schematic and printed-circuit board layout diagrams are used. Input signals are injected at the proper points — found most quickly by using layout of the printed-circuit board instead of the schematic. An AUDIO (AC) VTVM connected to the test points should indicate voltages close to those values shown in the boxes on the schematic. Many of the signal levels in the input stages are only a few millivolts — they can not be read on the AC ranges supplied on most Vacuum-Tube AC/DC Volt-ohmmeters (VTVMs). Even with a 1-volt range a signal level of 100 millivolts (.1 volt) will be the first 1/10 of the meter scale. A reading of 1 millivolt (.001 volt) will hardly even move the meter needle.

## MAIN CHASSIS PARTS DESCRIPTION LIST

### CAPACITORS

10% Tolerance for all fixed capacitors, unless otherwise noted or marked GMV (guaranteed minimum value). All capacitors not marked uF are pF (uF).

Symbol	Description	Part No.			
C1	Ceramic, 21, 5%, N750, 1000V	C50070-32	C5	Ceramic, 8, 5%, NPO, 1000V	C50070-45
C2	Ceramic, 1000, GMV, 500V	C50089-2	C6	Ceramic, Trimmer	C662-123
C3	Ceramic, Feed thru, 1000, GMV	C592-187	C7A, B, C	Variable, FM Tuning	C966-117-1
C4	Ceramic, 1000, GMV, 500V	C50089-2	C8	Ceramic, Trimmer	C662-123
			C9	Ceramic, 8, 5% NPO, 1000V	C50070-45
			C10	Ceramic, 24, 5%, N150, 1000V	C50070-8
			C11	Ceramic, 100, 5%, N1500, 1000V	C50070-19
			C12	Ceramic, 68, 5%, N750, 1000V	C50070-35
			C13	Ceramic, 1000, 1000V	C50072-3
			C14, 15	Ceramic, 100, N1500, 1000V	C50070-6
			C16	Ceramic, Trimmer	C662-123

## MAIN CHASSIS PARTS DESCRIPTION LIST

## ALIGNMENT INSTRUCTIONS

C17 Ceramic, 10 ±.5pF P100, 500V C18, 19, 20 Ceramic, Feedthru, 1000, GMV C21 Ceramic, .02, +80-20%, 100V C22 Ceramic, 5000 +80-20%, 500V C23 Ceramic, 2700, 1000V C24, 25 Ceramic, 5000, +80-20%, 500V C26 Ceramic, 2700, 1000V C27 Ceramic, 5000, +80-20%, 500V C28 Ceramic, 24, 5%, N1500, 1000V C29 Ceramic, 2700, 1000V C30 Ceramic, 5000, +80-20%, 500V C31 Ceramic, 1000, 1000V C32 Ceramic, 18, N470, 1000V C33 Ceramic, 5000, +80-20%, 500V C34 Ceramic, 2700, 1000V C35 Ceramic, 5000, +80-20%, 500V C36, 37 Ceramic, 330, 1000V C38 Electrolytic, 8 uF, 50V C39 Ceramic, .02 uF, GMV, 1000V C40, 41 Molded, .01 uF, 20%, 600V C42, A, B, C, D Electrolytic, 4 Section: A-40 uF, 300V B-40 uF, 300V C-40 uF, 250V D-40 uF, 250V C43, 44, 45 - Deleted - C46, 47 Electrolytic, 500 uF, 35V C48 Electrolytic, 200 uF, 35V C49, 50, 51, 52 Ceramic, 5000, +80-20%, 500V C53 Mylar, .1 uF, 20%, 250V C54 Ceramic, 5000, +80-20%, 500V C55 Electrolytic, 16 uF, 10V C56 - Deleted - C57 Mylar, .022 uF, 400V C58, 59 Mylar, .1 uF, 400V C60 Mylar, .022 uF, 400V C61 Ceramic, .01 uF, 20%, 500V C62 Ceramic, Feedthru, 1000, GMV	CC20A1100D5 C592-187 C50095-1 C50089-6 C50072-17 C50089-6 C50072-17 C50089-6 C50070-8 C50072-17 C50089-6 C50072-3 C50070-13 C50089-6 C50072-17 C50089-6 C50072-17 C629-138 C50071-6 C2747 C670-125B C50483-17 C50483-7 C50089-6 C50575-1 C50089-6 C50483-10 C50574-8 C50574-10 C50574-8 C50089-3 C592-187	R38 Composition, 3.3K, 10%, 1/2W R39 10K R40 100K R41 270 R42 Composition, 100, 10%, 1/2W R43, 44 Composition, 220, 10%, 1/2W R45 Composition, 22, 10%, 1/2W R46 120K R47 330K R48 100K R49 180K R50 470K R51 15K R52 Potentiometer, 500K, Output Level, Left R53 470K R54 1.8M, 5%, 1/3W R55 Composition, 15M, 10%, 1/2W R56, 57 100K, 5%, 1/3W R58 Composition, 15M, 10%, 1/2W R59 1.8M, 5%, 1/3W R60 470K R61 15K R62 Composition, 820K, 10%, 1/2W R63 Potentiometer, 500K, Output Level, Right	RC20BF332K R12DC103J R12DC104J R12DC271J RC20BF101K RC20BF221K RC20BF220K R12DC124J R12DC334J R12DC104J R12DC184J R12DC474J R12DC153J R50103-6 R12DC474J R33DC185J RC20BF156K R33DC104J RC20BF156K R33DC185J R12DC474J R12DC153J RC20BF824K R50103-6
--	--	---	---

### CHOKES, COILS AND TRANSFORMERS

Symbol	Description	Part No.
L1	Coil, Antenna	L966-113
L2	Coil, RF	L1034-113
L3	Coil, Mixer	L966-115
L4	Coil Assembly, Oscillator	A5966-107
L5	Choke, .68 Microhenry	L50066-1
L6, 7	Choke, 1.2 Microhenry	L50066-3
L8	Choke, 3.3 Microhenry	L50066-3
T1	Transformer, Power	T1128-115
Z1	Transformer, IF	ZZ50210-20
Z2	Transformer, IF	ZZ50210-39
Z3	Transformer, IF	ZZ50210-21
Z4	Transformer, IF	ZZ50210-61
Z5	Transformer, Ratio Detector	ZZ50210-9

### MISCELLANEOUS

Symbol	Description	Part No.
CR1	Diode, AA113	V50260-22
CR2	Diode, V1112	V1112
CR3	Rectifier, Selenium	SR50279-1
CR4	Rectifier, Selenium	SR950-149
F1	Fuse, 1A, Slo-Blo	F692-132
I1	Lamp, Muting	I50009-7
I2	Lamp, Stereo Beacon	I50594
I3	Lamp, Meter	I50009-8
I4, 5	Lamp, Dial	I50441-1
M1	Meter	M946-213
Q1	Transistor, 2N2924	TR2N2924
Q2	Transistor, 2N2925	TR2N2925
S1	Switch, Selector	S1127-130
S2	Switch, Muting	S1127-131
S3	Switch, Power	S50358-7
	Dipole Antenna	A550227-1
	Nameplate Holder	Z50557
	Muting Indicator Assembly	A550338-1
	Dress Panel	A1127-112
	Insert, Dress Panel Screened (Upper)	AS1127-122
	Insert, Dress Panel Screened (Lower)	AS1127-123
	Knob, Selector, Muting, Power	E50562-1
	Knob, Tuning	E50566-2
	Drive Wheel for Variable	E50588
	Stereo Beacon Lampholder	E1128-127-2
	Jack, Tape	J50545
	Dial Glass	N1127-107
	Nameplate Insert (Bird)	N50591-1
	Nameplate Insert (Professional Series)	N50591-2

### RESISTORS AND POTENTIOMETERS

Deposited carbon in ohms, 5% tolerance, 1/8-watt unless otherwise noted. K = Kilohm, M = Megohm

Symbol	Description	Part No.
R1	Composition, 270, 10%, 1/2W	RC20BF271K
R2	Composition, 100K, 10%, 1/2W	RC20BF104K
R3, 4	220K	R12DC224J
R5	1K	R12DC102J
R6	390	R12DC391J
R7	1.2K	R12DC102J
R8	56K	R12DC563J
R9	Wirewound 4.7K, 10%, 3W	RPG3W472K
R10	Composition, 3.3K, 10%, 1W	RC30BF332K
R11	Composition, 180, 10%, 1/2W	RC20BF181K
R12	39K	R12DC393J
R13	Composition, 27K, 10%, 1/2W	RC20BF273K
R14	Composition, 1K, 10%, 1/2W	RC30BF102K
R15	Composition, 150, 10%, 1/2W	RC20BF151K
R16	Composition, 47K, 10%, 1/2W	RC20BF473K
R17	Composition, 1K, 10%, 1/2W	RC20BF102K
R18	68K	R12DC683J
R19	2.2M, 5%, 1/3W	R33DC225J
R20	820K	R12DC824J
R21	5.6K	R12DC562J
R22	Composition, 1K, 10%, 1/2W	RC20BF102K
R23	Composition, 82K, 10%, 1/2W	RC20BF823K
R24	1K	R12DC102J
R25	47K	R12DC473J
R26	1M	R12DC105J
R27	Composition, 68K, 10%, 1/2W	RC20BF683K
R28	Composition, 1K, 10%, 1/2W	RC20BF102K
R29	270	R12DC271J
R30	1.5K	R12DC152J
R31	1K	R12DC102J
R32, 33	6.8K	R12DC682J
R34	Control, 25K, Muting 2	R50694-2
R35	Control, 25K, Muting 1	R50694-2
R36, 37	Wirewound, 270, 10%, 3W	RPG3W271K

### Read These Instructions With Extreme Care Before Attempting Alignment.

**CHASSIS:** Turn the TUNING knob completely counterclockwise without forcing. Dial pointer should be at zero index mark on logging scale. If not, reset the dial pointer. Disconnect the external antenna. When using an oscilloscope for alignment, set the AUDIO LEVEL control for no overload, as shown by the proper waveform shape. Set remaining controls as follows: SELECTOR, MONO; MUTING, OFF; POWER, ON.

**SIGNAL GENERATOR:** The signal generator equipment must be able to supply RF ±22.5 KC deviation at 400 cps.

**INDICATOR:** DC VTVM, and scope for alignment.

**ALIGNMENT:** Allow the chassis and test instruments to warm up for at least 15 minutes. Adjust the line voltage for 117 volts AC, 50-60 cps. Use fully insulated tools; a small screwdriver for all trimming capacitors.

**NOTES:**—For accurate alignment, signal generator output voltage must be adjusted to produce meter readings within the range specified in the INDICATION column for each step.

Signal generator frequency should be held constant for IF, limiter and ratio detector alignment (Z1 through Z5).

Do not tamper with adjustments on multiplex sub-chassis. These circuits are extremely stable and should require no service other than tube replacement, which does not affect alignment. Multiplex alignment requires special equipment and procedures. We recommend the FISHER MPX-300 Multiplex Generator for all multiplex servicing applications.

### FM ALIGNMENT (Tuner Only)

STEPS	CHASSIS		SIGNAL GENERATOR			INDICATOR		ALIGNMENT	
	TUNING		COUPLING	FREQ.	MOD.	TYPE CONNECTION	ADJUST	INDICATION	
1	Point of no signal and no interference		FM generator connected to TEST POINT 1 through 0.5 pF (or less), clipped to wire insulation or "gimmick".	10.7 MC	None	Connect DC VTVM to TEST POINT 2	Z1, Z2 and Z3 top for max. indication	Between —2 and —5 volts	
2	Point of no signal and no interference		FM generator connected to TEST POINT 1 through 0.5 pF (or less), clipped to wire insulation or "gimmick".	10.7 MC	None		Z4, bottom	Maximum indication on tuning meter (M1)	
3	Point of no signal and no interference		FM generator connected to TEST POINT 1 through 0.5 pF (or less), clipped to wire insulation or "gimmick".	10.7 MC	None	Connect DC VTVM across C38.	Z5, bottom, for max. indication	Between 15 and 20 volts	
4	Point of no signal and no interference		FM generator connected to TEST POINT 1 through 0.5 pF (or less), clipped to wire insulation or "gimmick".	10.7 MC	None	Connect DC VTVM to TEST POINT 4	Z5, top,	Zero volts — between negative and positive swing	
5	90 MC		FM generator connected to 300 ohm terminals through 120 ohm carbon resistors	90 MC	30% FM (22.5 KC Dev.) at 400 cps.	DC VTVM to test point 2 and scope to RIGHT or LEFT OUTPUT jack	L4, L3, L2 for sinusoidal waveform and max. neg. voltage	Less than —4 volts	
6	106 MC		FM generator connected to 300 ohm terminals through 120 ohm carbon resistors	106 MC	30% FM (22.5 KC Dev.) at 400 cps.	DC VTVM to test point 2 and scope to RIGHT or LEFT OUTPUT jack	C16, C8 and C6 for sinusoidal waveform and max. neg. volt.	Less than —4 volts	
7	Repeat steps 5 and 6 for proper dial calibration and maximum output.								

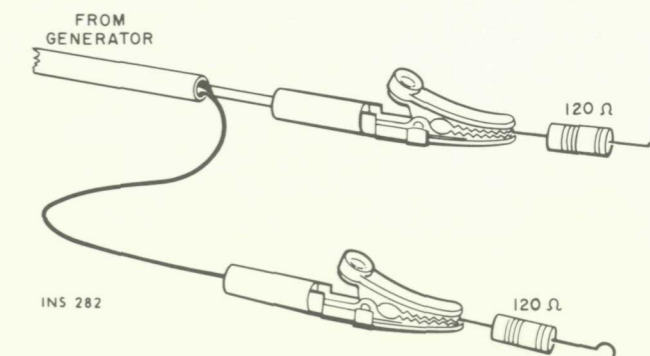

# 1249-2 MULTIPLEX DECODER

## MULTIPLEX DECODER TESTS

- Modulate FM generator with 19 kc,  $\pm 6.5$  kc deviation. (Use external modulation if necessary.)
- Connect the FM generator output to the antenna terminals of the unit under test.
- With the FM generator set for an output of 25  $\mu$ V at the antenna terminals the stereo indicator should light up. If the generator output is reduced to 5  $\mu$ V, at the antenna terminals, the indicator light should remain ON.
- Reduce FM generator output to zero and the indicator light should go OFF.
- If the stereo indicator light does not respond properly to the tests above, readjust the trigger control (R401) until the stereo indicator lamp just turns ON with a 4  $\mu$ V signal applied to the antenna terminals.

## PREFERRED ALIGNMENT INSTRUCTIONS

(Using multiplex generator with RF and 19 kc outputs and with 1 kc modulation)

In Table 1, below, a multiplex generator with an RF output is used. This is the better method of alignment since the multiplex circuitry is connected to the tuner with which it will be used. Check the alignment of the IF stages before making multiplex adjustments. Poor IF alignment can make proper multiplex operation impossible.

This table is based on the FISHER Model 300 multiplex generator. Another alignment procedure, for MPX generators without an RF output, is shown in Table 2.

**TEST EQUIPMENT:** Multiplex Generator, Audio (AC) Vacuum-Tube Voltmeter (RMS type preferred), Vacuum-Tube Voltmeter (DC VOM), Oscilloscope (100 kc minimum) with external sweep input.

**WARNING:** Use only the proper alignment tool to prevent core breakage.

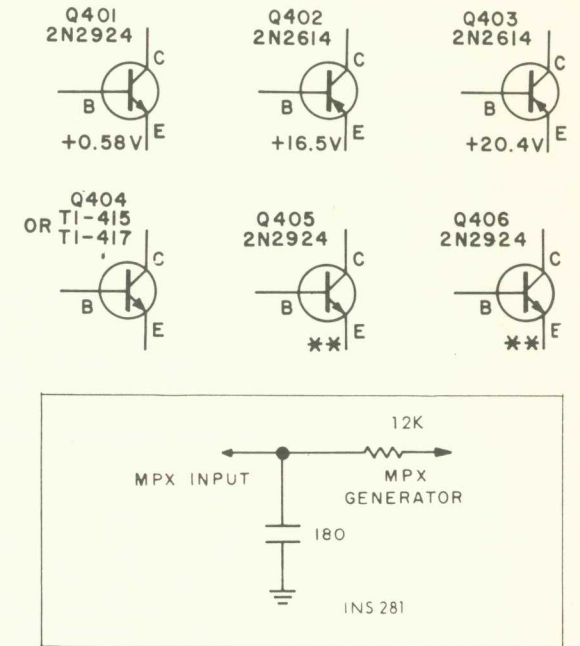
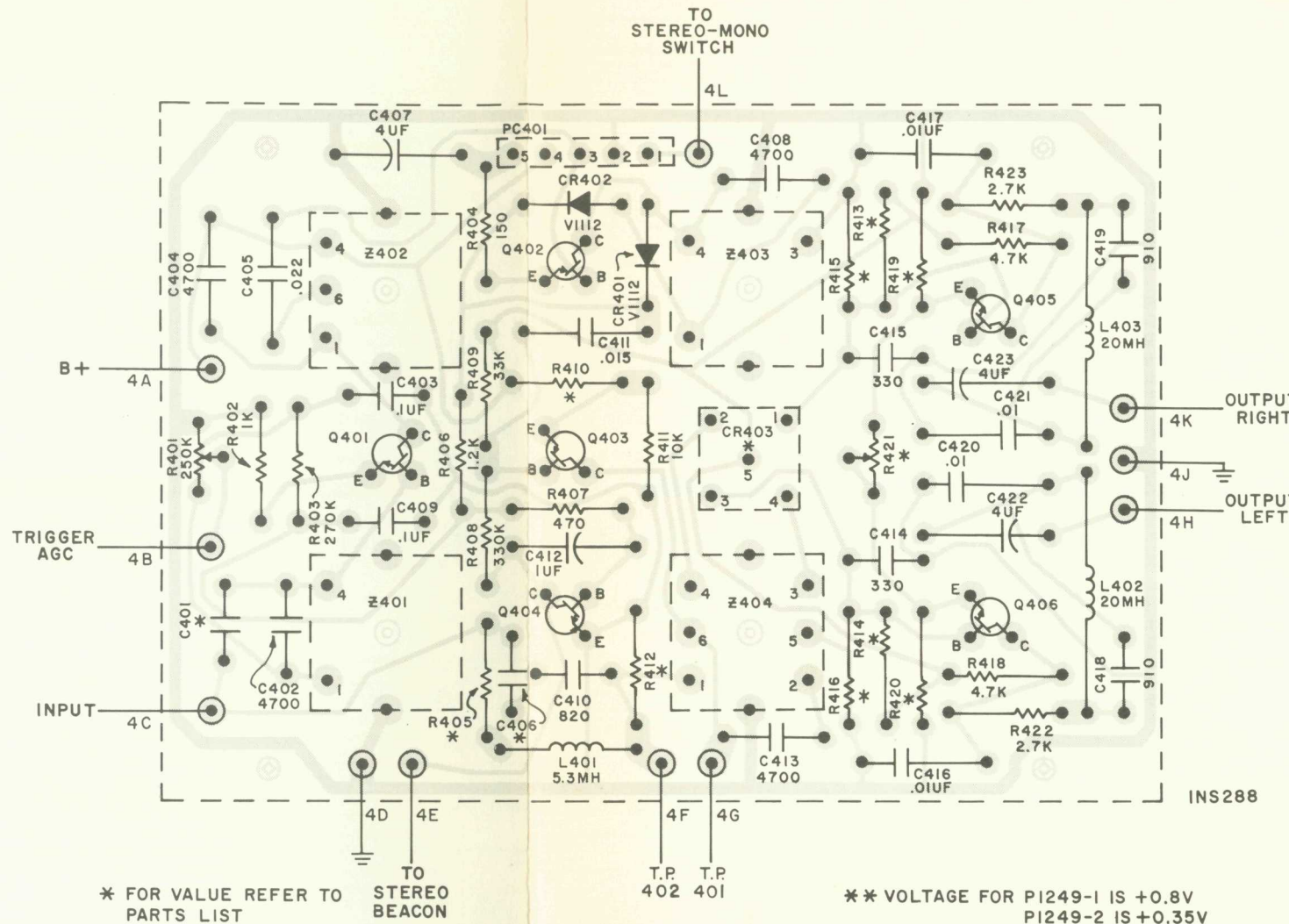

FIGURE 1. Multiplex-alignment hi-pass filter circuit.

## ALTERNATE ALIGNMENT INSTRUCTIONS

(For multiplex generators without an RF output)

Disconnect the ratio detector from the multiplex unit before using this procedure. A low-pass filter (Figure 2) is used between the MPX generator output and the input to the multiplex circuitry. It has about the same loading effect as the output of the ratio detector in the tuner.

TABLE 1

MULTIPLEX-GENERATOR RF OUTPUT CONNECTED TO ANTENNA TERMINALS

STEP	GENERATOR MODULATION	RF DEV.	INDICATOR TYPE AND CONNECTION	ALIGNMENT	
				ADJUST	INDICATION
1	70 to 76 kc (connect external audio generator to SCA input of multiplex generator.)	$\pm 25$ kc	Audio (AC) VTVM input to TP402 with a 10 pF capacitor in series with lead.	--	Read minimum AC voltage between 70 and 76 kc.
2	19 kc pilot only	$\pm 6.5$	DC VTVM to TP401	Z401, 402, 403 and 404	Maximum AC voltage (38 kc)
3	Composite MPX signal 1 kc on left channel only	$\pm 75$ kc	Audio (AC) VTVM and oscilloscope vertical input to left channel output lug (4H)	Z402	Maximum AC voltage with clean 1 kc sine wave on oscilloscope
4	Composite MPX signal 1 kc on right channel only	$\pm 75$ kc	Same as Step 3	MPX Separation Control (R421)	Minimum reading on Audio (AC) VTVM--should be at least 35db below reading obtained in Step 3.
5	Same as Step 4	$\pm 75$ kc	Audio (AC) VTVM and oscilloscope vertical input to right channel output lug (4K)	--	Same Audio (AC) VTVM reading as obtained in Step 3 ( $\pm 2$ db); clean 1kc sine wave on scope.
6	Same as Step 4	$\pm 75$ kc	Same as Step 5		Minimum reading on Audio (AC) VTVM should be at least 35db below reading in Step 5.

TABLE 2

COMPOSITE OUTPUT OF MULTIPLEX GENERATOR CONNECTED TO INPUT OF MPX DECODER THROUGH LOW-PASS FILTER

STEP	GENERATOR MODULATION	LEVEL (RMS)	INDICATOR TYPE AND CONNECTION	ALIGNMENT	
				ADJUST	INDICATION
1	70 to 76 kc.	100mV	Audio (AC) VTVM input to TP402 with a 10 pF capacitor in series with lead.	--	Read minimum AC voltage between 70 and 76 kc.
2	19 kc pilot only	50mV	DC VTVM to TP401	Z401, 402, 403 and 404	Maximum AC voltage (38 kc)
3	Composite MPX signal 1 kc on left channel only	300mV	Audio (AC) VTVM and oscilloscope vertical input to left channel output lug (4H)	Z402	Maximum AC voltage with clean 1 kc sine wave on oscilloscope
4	Composite MPX signal 1 kc on right channel only	300mV	Same as Step 3	MPX Separation Control	Minimum reading on Audio (AC) VTVM--should be at least 35db below reading obtained in Step 3.
5	Same as Step 4	300mV	Audio (AC) VTVM and oscilloscope vertical input to right channel output lug	--	Same Audio (AC) VTVM reading as obtained in Step 3 ( $\pm 2$ db); clean 1kc sine wave on scope.
6	Same as Step 4	300mV	Same as Step 5		Minimum reading on Audio (AC) VTVM should be at least 35db below reading obtained in Step 5.

# P 1249-2 MULTIPLEX DECODER

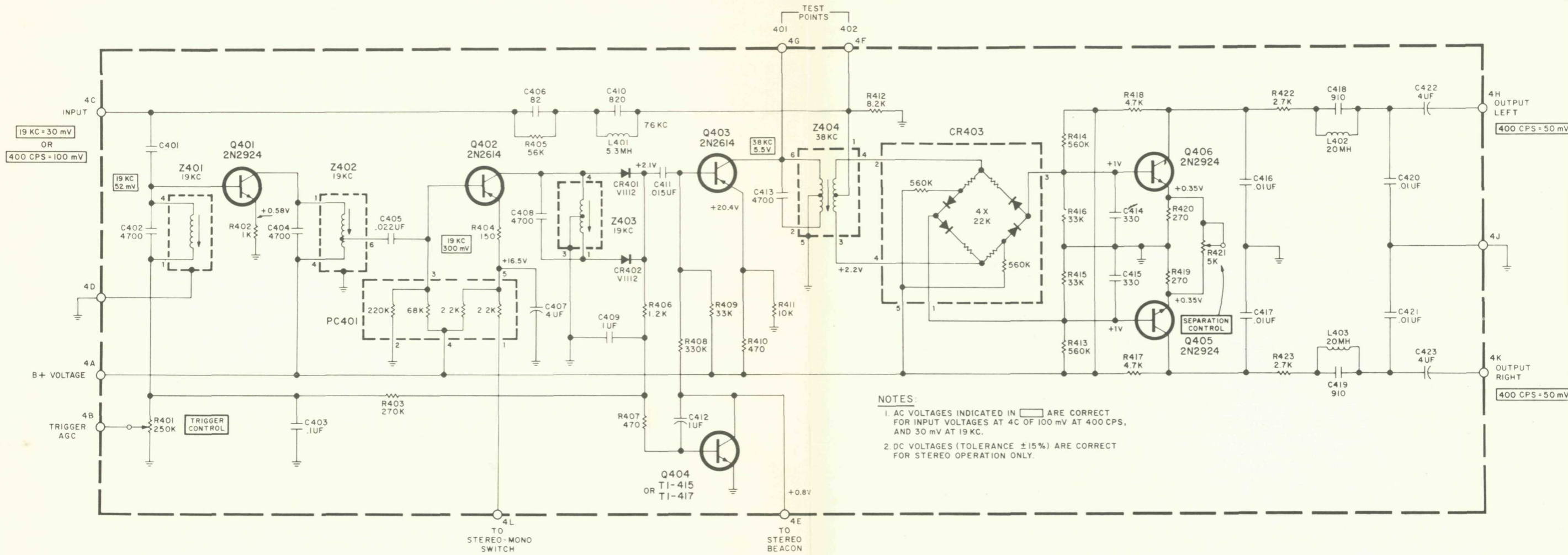

**NOTES:**  
 1. AC VOLTAGES INDICATED IN   ARE CORRECT FOR INPUT VOLTAGES AT 4C OF 100 mV AT 400 CPS, AND 30 mV AT 19 KC.  
 2. DC VOLTAGES (TOLERANCE  $\pm 15\%$ ) ARE CORRECT FOR STEREO OPERATION ONLY.

P1249-2  
AW#2341B

## PARTS DESCRIPTION LIST

TI 415  
TI 417

2N2924  
2N2925

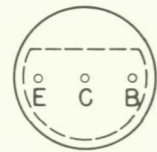
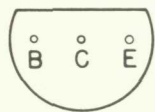

2N2613  
2N2614

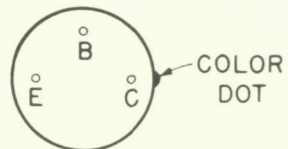

INS 305

### CAPACITORS

10% tolerance for all fixed capacitors, unless otherwise noted or marked GMV (guaranteed minimum value). All capacitors not marked uF are pF (uF).

Symbol	Description	Part No.
C401	*Ceramic, 220, 5%, N1500	C50568-6
C402	Mica, Silver, 4700, 5%, 100VDC	C50571-2
C403	Mylar, 0.1uF, 20%, 250V	C50635-1
C404	Polystyrene, 4700, 5%, 33V	C50636-23
C405	Mylar, .022uF, 100V	C50574-7
C406	Ceramic, 15, P100, 1000V	C50568-14
C407	Electrolytic, 4uF, 35V	C50483-1
C408	Polystyrene, 4700, 5%, 33V	C50636-23
C409	Mylar, 0.1uF, 20%, 250V	C50635-1
C410	Polystyrene, 220, 5%, 33V	C50636-3
C411	Mylar, .015uF, 100V	C50574-2
C412	Electrolytic, 1uF, 70V	C50483-16
C413	Polystyrene, 4700, 5%, 33V	C50636-23
C414, 415	Polystyrene, 330, 5%, 33V	C50636-4
C416, 417	Mylar, .01uF, 5%, 100V	C50574-1
C418, 419	Polystyrene, 910, 5%, 33V	C50636-6
C420, 421	Mylar, .01uF, 5%, 100V	C50574-1

C422, 423	Electrolytic, 4uF, 35V	C50483-1
C424	Polystyrene, 120, 5%, 33V	C50636-8
† Used on PB1249-1 Board—(Tube-type IF Amplifiers)		
* Used on PB1249-2 Board—(Transistor-type IF Amplifiers)		

### RESISTORS AND POTENTIOMETERS

Deposited Carbon, in ohms, 5% tolerance, 1/8-watt, unless otherwise noted. K=Kilohms, M=Megohms.

Symbol	Description	Part No.
R401	Potentiometer, Trimmer, 250K, $\pm 30\%$	R50694-4
R402	Composition, 1K, 10%, 1/2 W	RC20BF102K
R403	270K	R12DC274J
R404	150	R12DC151J
R405	39K	R12DC393J
R406	1.2K	R12DC122J
R407	470	R12DC471J
R408	330K	R12DC334J
R409	33K	R12DC333J
R410	390	R12DC391J
R411	10K	R12DC103J
R412	15K	R12DC153J
R413, 414	470K	R12DC474J

R415, 416	68K	R12DC683J
R417, 418	4.7K	R12DC472J
R419, 420	560	R12DC561J
R421	Trimmer, 25K, $\pm 30\%$ , Separation Control	R50694-2
R422, 423	2.7K	R12DC272J
R424	22K	R12DC223J

### MISCELLANEOUS

Symbol	Description	Part No.
CR401, 402	Diode, V1112	V1112
CR403	Ring Demodulator	V50260-29
L401	Coil, 20mH	L50334-2
L402, 403	Coil, 20mH	L50334-6
Q401	Transistor, 2N2924	TR2N2924-18
Q402, 403	Transistor, 2N2614	TR2N2614
Q404	Transistor, TI 417	TR9100-18
Q405, 406	Transistor, 2N2924	TR2N2924-18
PC401	Printed Circuit	PC50B187-21
Z401	Transformer, 19Kc	ZZ50210-63
Z402	Transformer, 19Kc	ZZ50210-67
Z403	Transformer, 19Kc	ZZ50210-64
Z404	Transformer, 38Kc	ZZ50210-65

# SCHEMATIC DIAGRAM

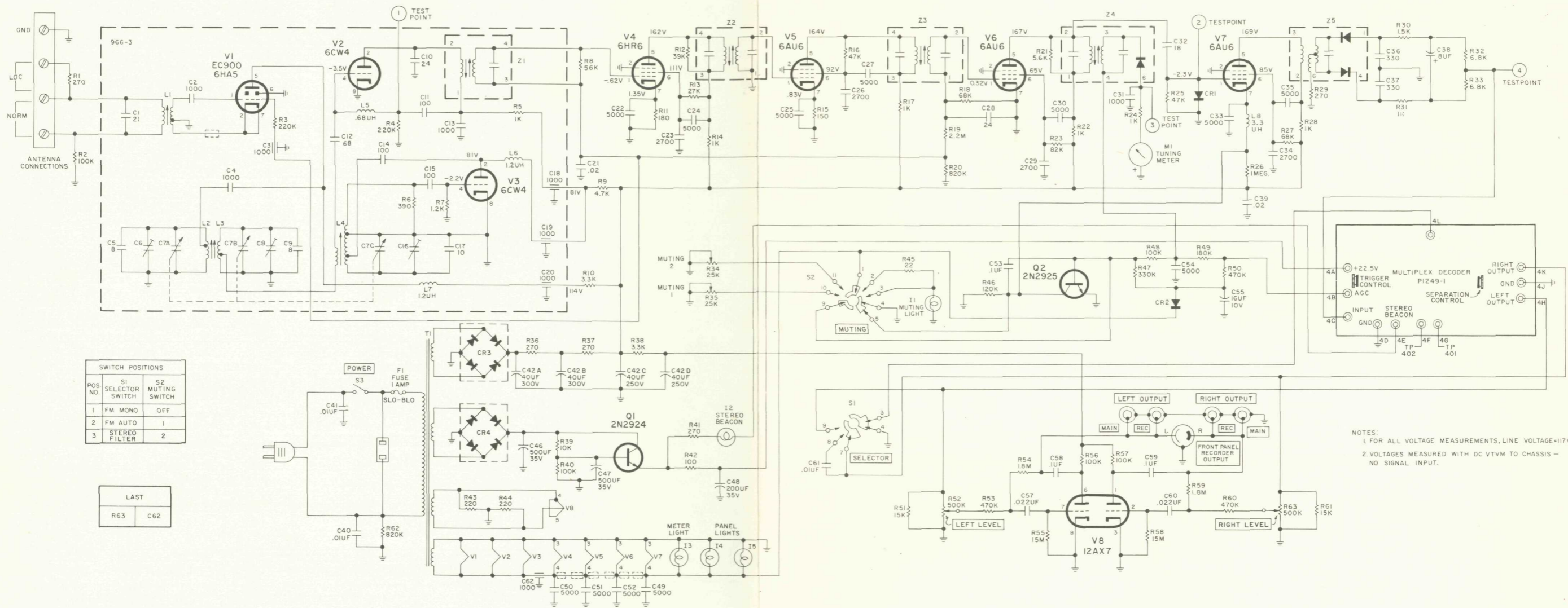

SWITCH POSITIONS		
POS. NO.	S1 SELECTOR SWITCH	S2 MUTING SWITCH
1	FM MONO	OFF
2	FM AUTO	1
3	STEREO FILTER	2

LAST	
R63	C62

NOTES:  
 1. FOR ALL VOLTAGE MEASUREMENTS, LINE VOLTAGE=117VAC  
 2. VOLTAGES MEASURED WITH DC VTVM TO CHASSIS - NO SIGNAL INPUT.

If replacement parts are out of stock, locally, they may be obtained directly from the Parts Department of FISHER Radio Corporation. They will be shipped "best way", either prepaid or C.O.D. unless otherwise specified.

For instrument-operation information and technical assistance write Richard Hamilton, Customer Service Department, FISHER Radio Corporation, Long Island City, New York 11101.

BECAUSE ITS PRODUCTS ARE SUBJECT TO CONTINUOUS IMPROVEMENT, FISHER RADIO CORPORATION RESERVES THE RIGHT TO MODIFY ANY DESIGN OR SPECIFICATION WITHOUT NOTICE AND WITHOUT INCURRING ANY OBLIGATION.

# COMPONENT CONNECTIONS

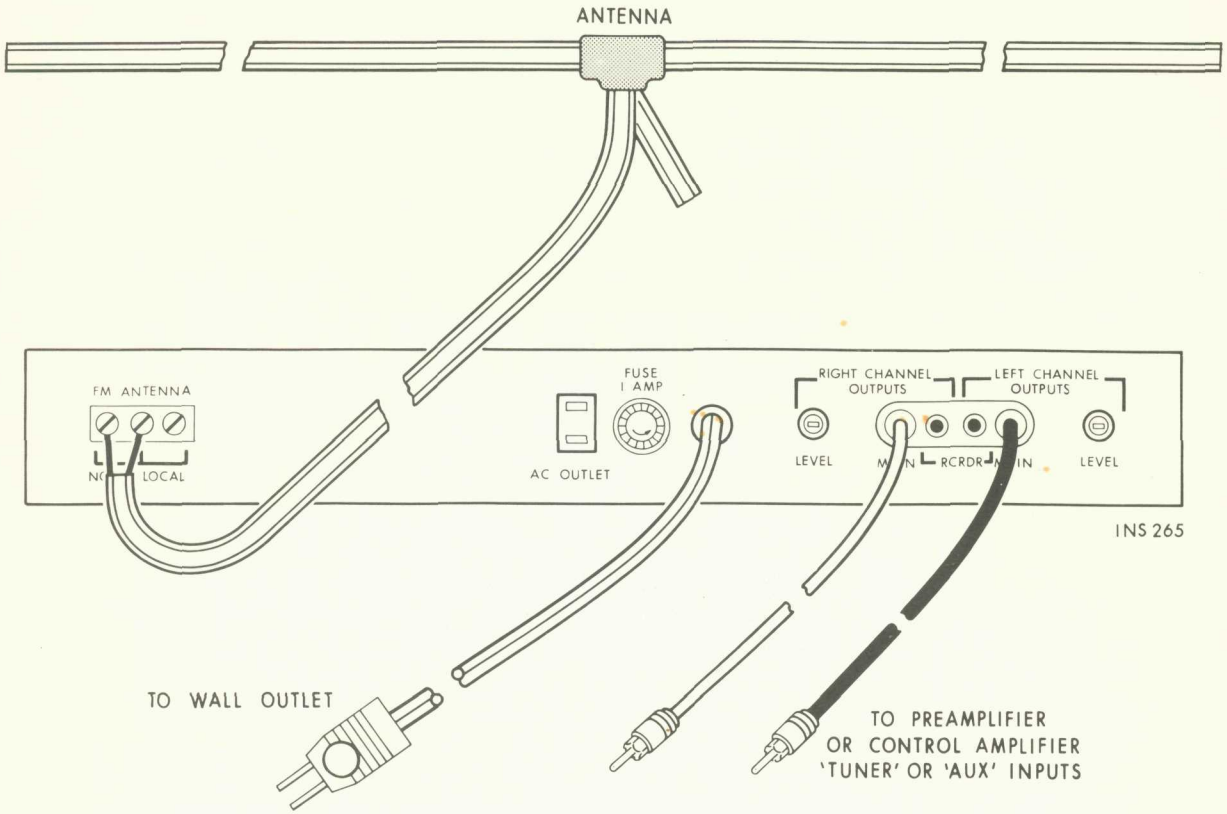

# TUBE LAYOUT

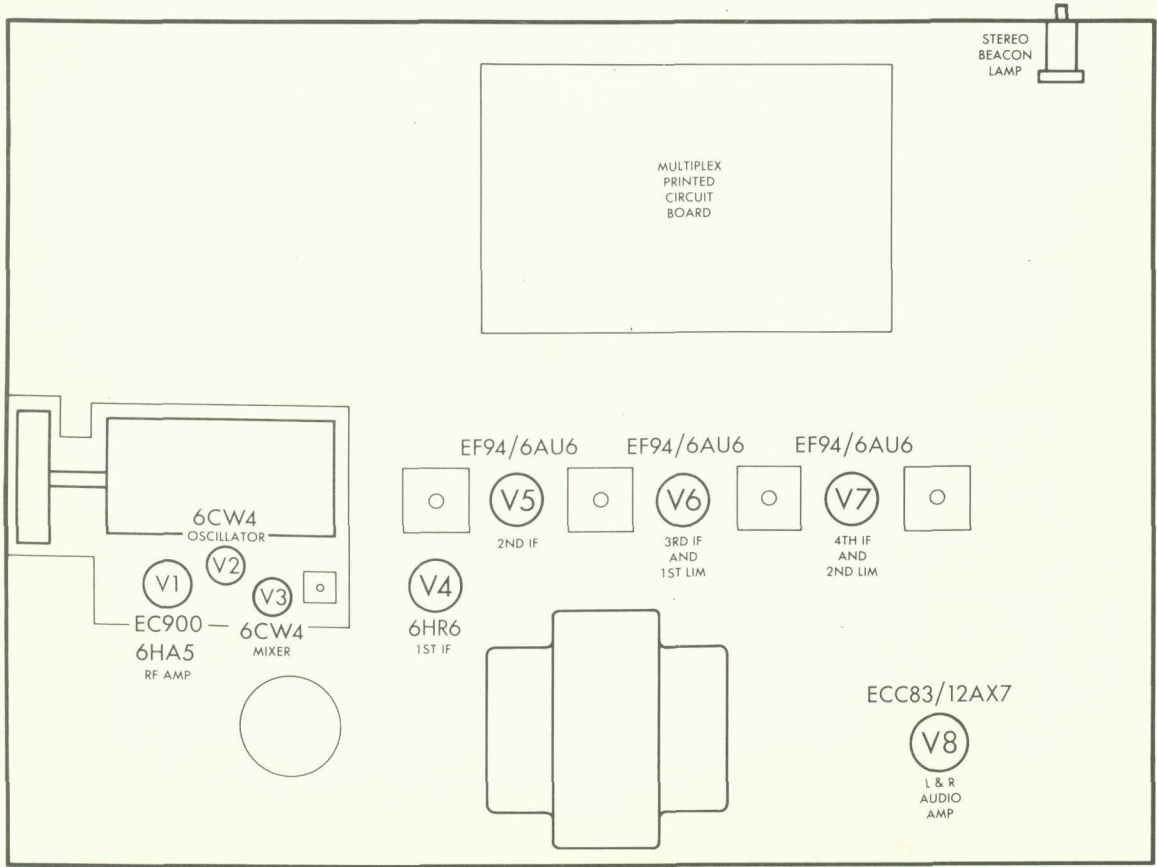

# DIAL STRINGING PROCEDURE

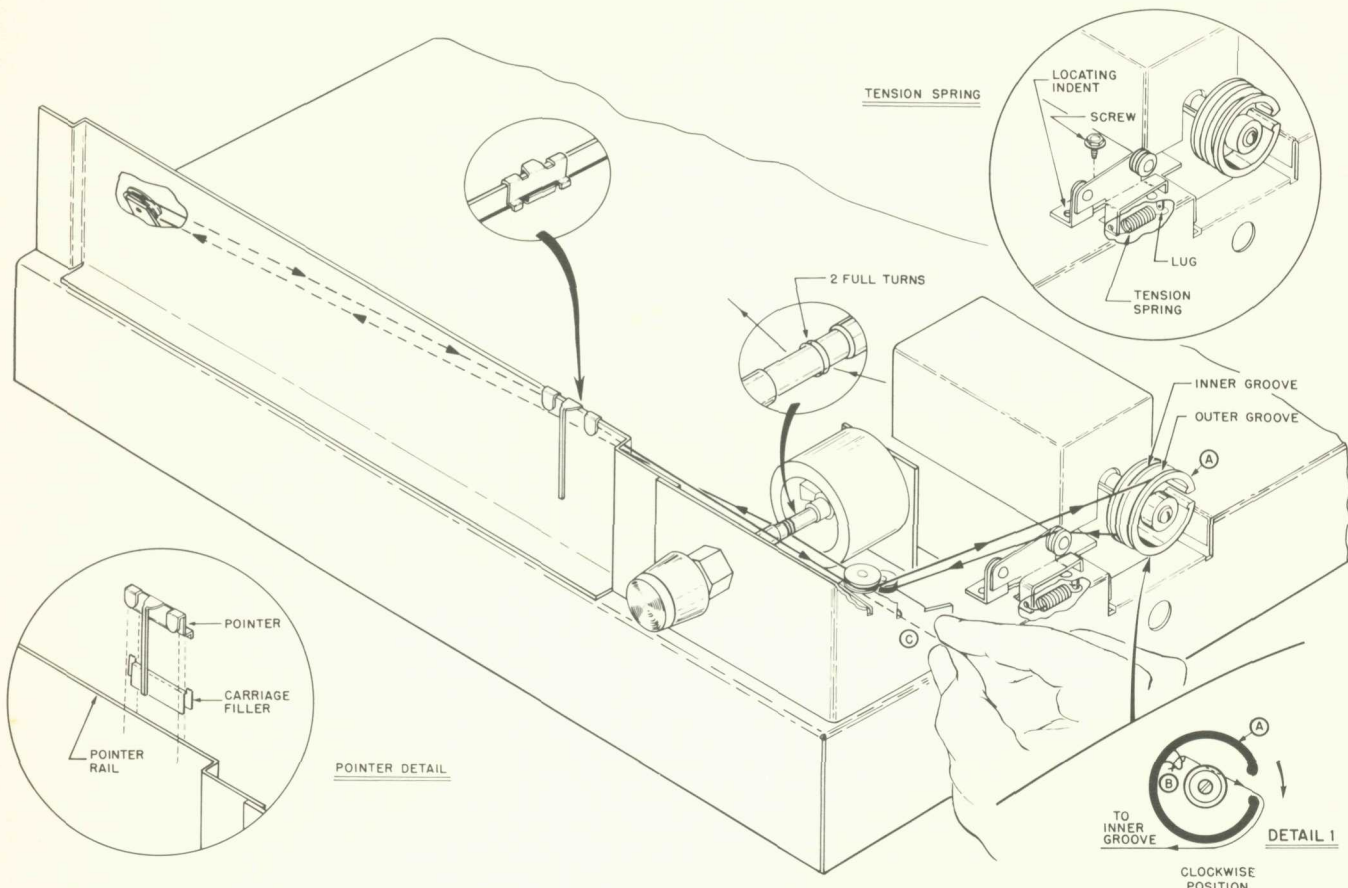

INS290

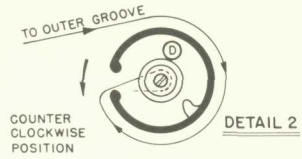
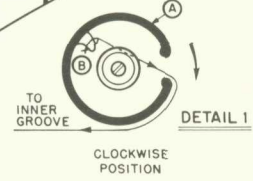

- 1—Rotate drive drum A (on tuning-capacitor shaft) to its maximum clockwise position.
- 2—Tie dial cord to ear B (inside drum A) as shown in Detail 1.
- 3—Run dial cord through slot in rim of drum A.
- 4—Set dial cord in INNER groove and over tension-spring pulley.
- 5—String dial cord, as shown, to point C.
- 6—Hold dial cord taut with left hand.

- 7—Wind drum A to maximum counterclockwise position (with right hand).
- 8—Wrap loose end of dial cord around drum A, in outer groove, as shown in Detail 2 (using right hand).
- 9—Secure loose end of dial cord under machine screw and washer (D) in the center of the drive drum.



**FISHER RADIO CORPORATION • NEW YORK**



PRELIMINARY SERVICE INFORMATION

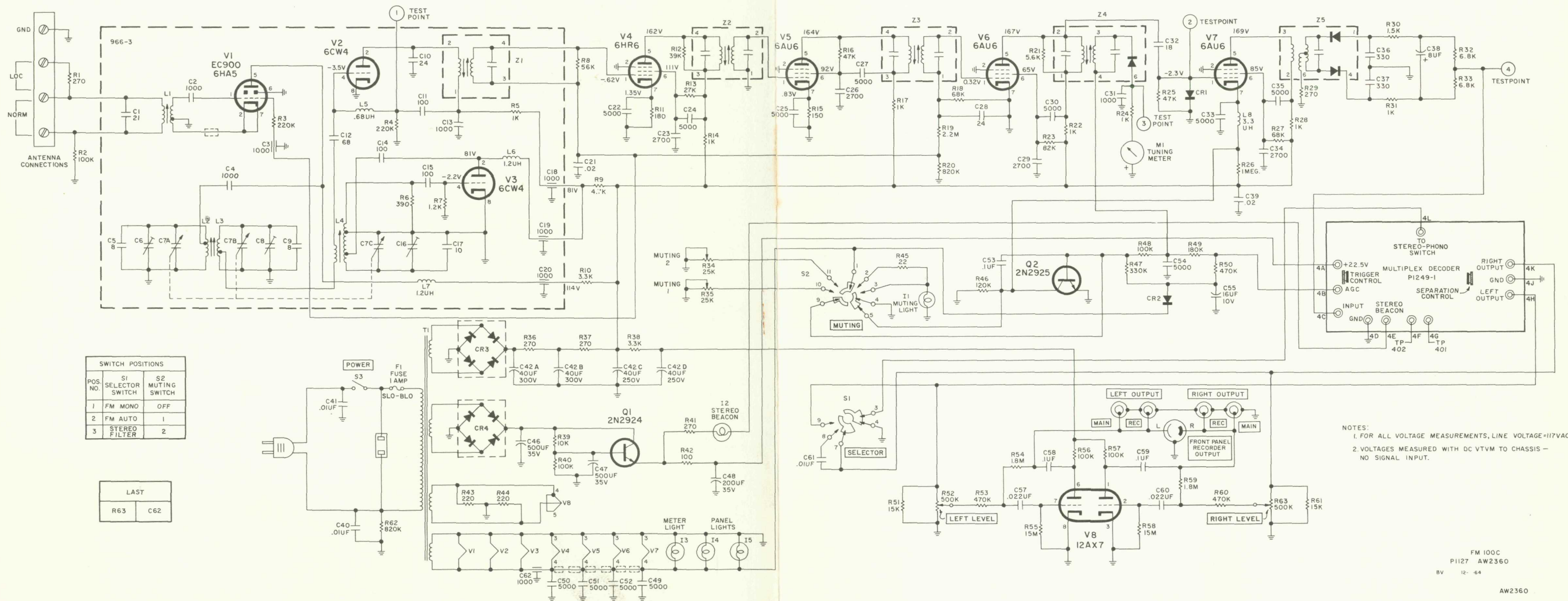

SWITCH POSITIONS		
POS. NO.	S1 SELECTOR SWITCH	S2 MUTING SWITCH
1	FM MONO	OFF
2	FM AUTO	1
3	STEREO FILTER	2

LAST	
R63	C62

NOTES:  
 1. FOR ALL VOLTAGE MEASUREMENTS, LINE VOLTAGE=117VAC  
 2. VOLTAGES MEASURED WITH DC VTVM TO CHASSIS - NO SIGNAL INPUT.